

CUBO MODULAR

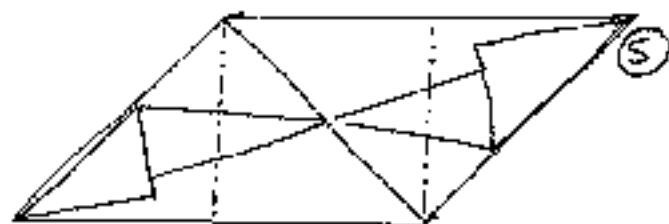

HACER 6 MÓDULOS
COMO ESTE 1 JUNTAR
ASÍ:

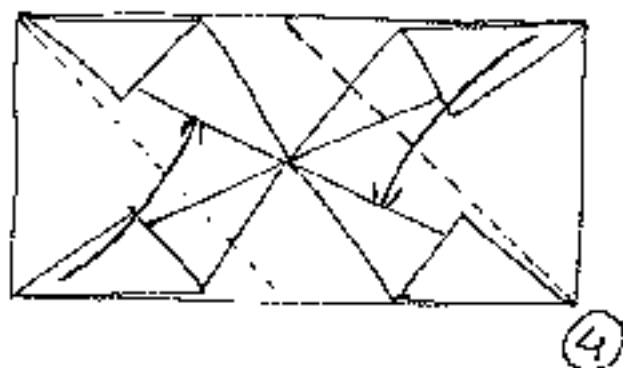
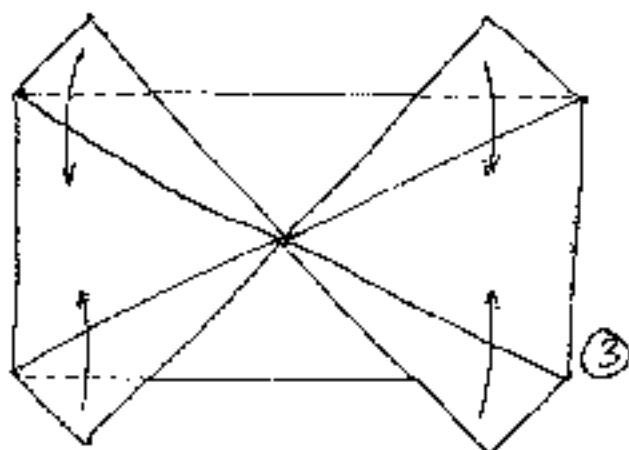
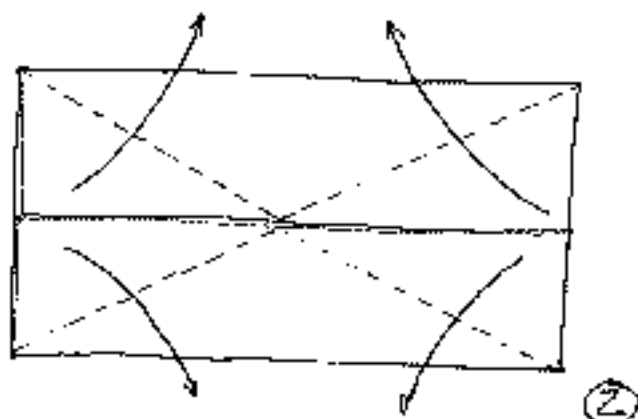
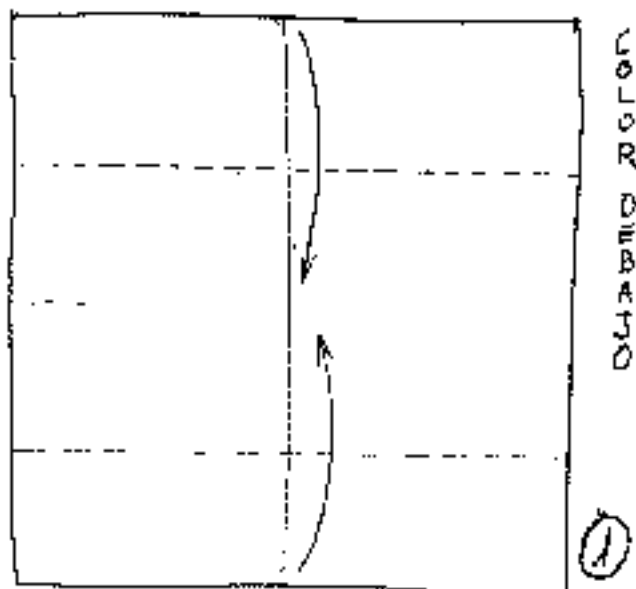
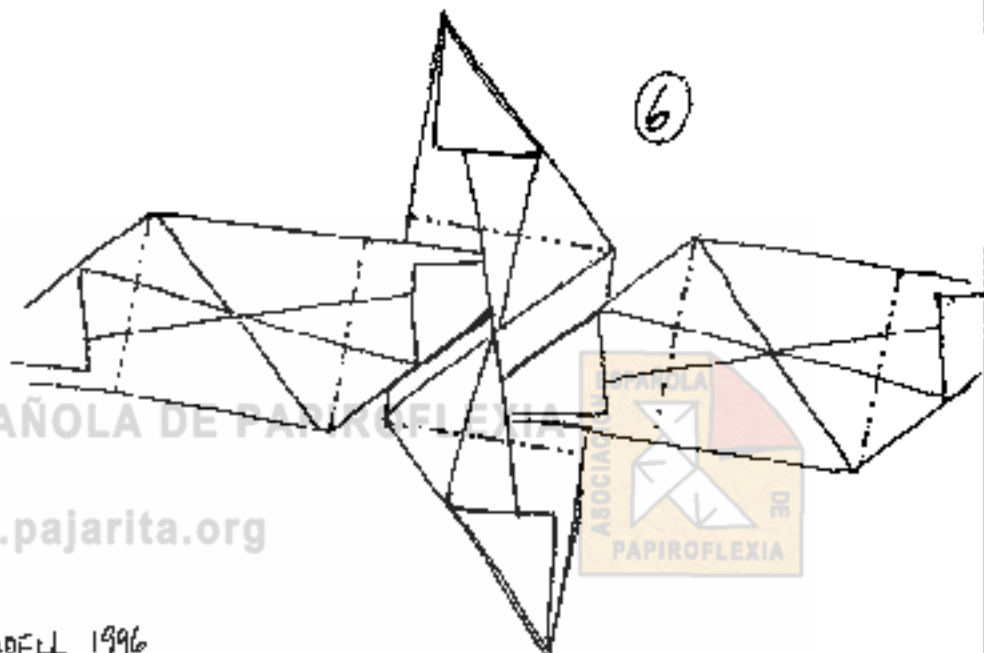
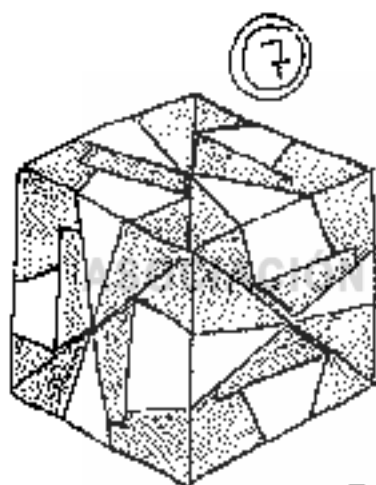

CUBO MODULAR

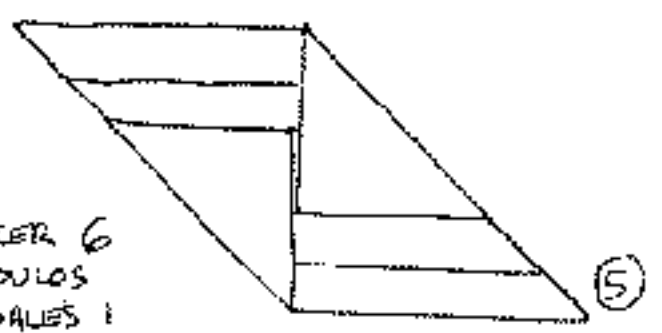
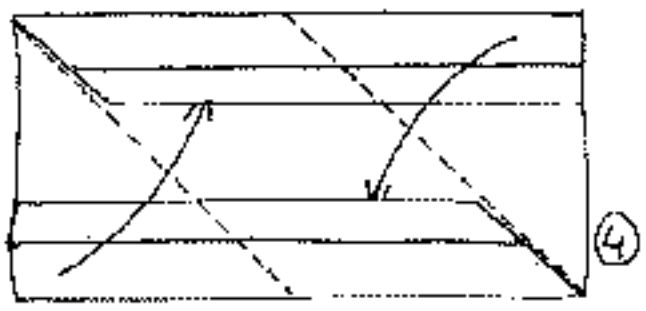
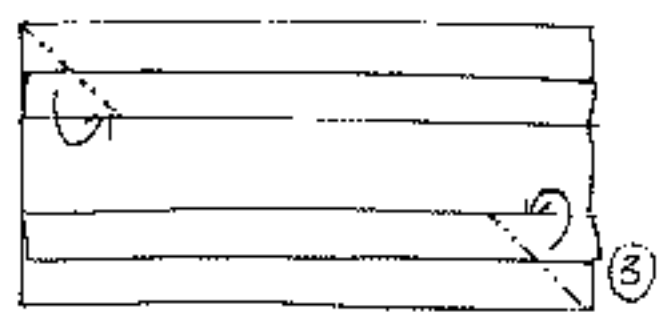
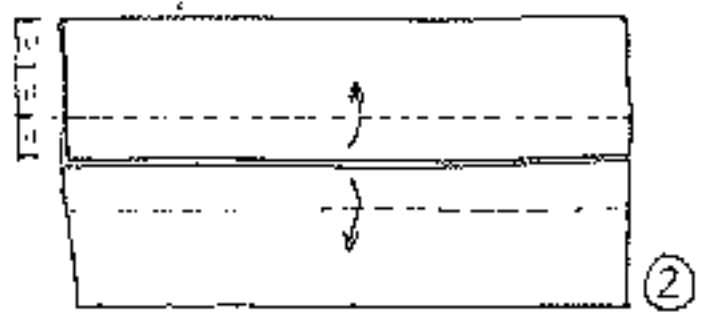
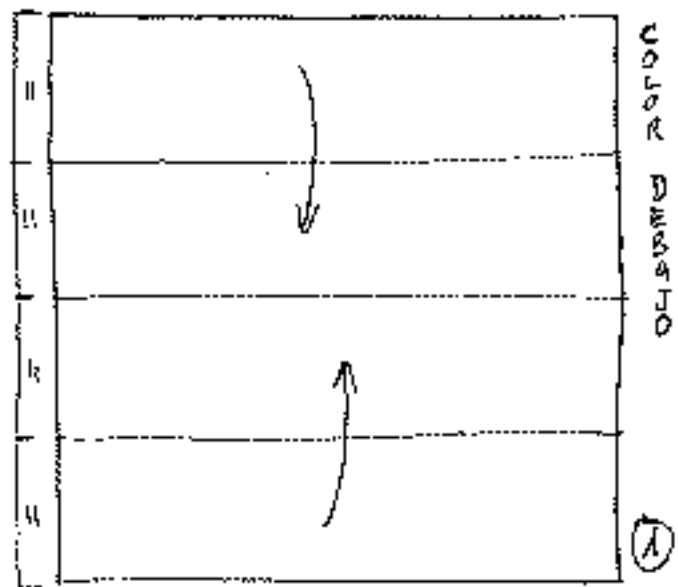

HACER 6
MÓDULOS
IGUALES Y
JUNTARLOS
ASÍ:

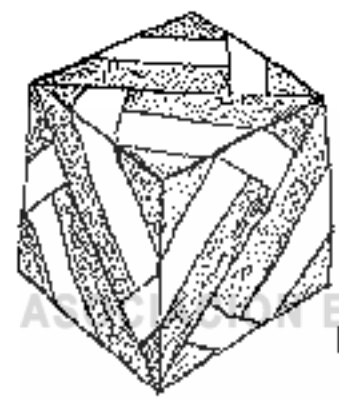

7

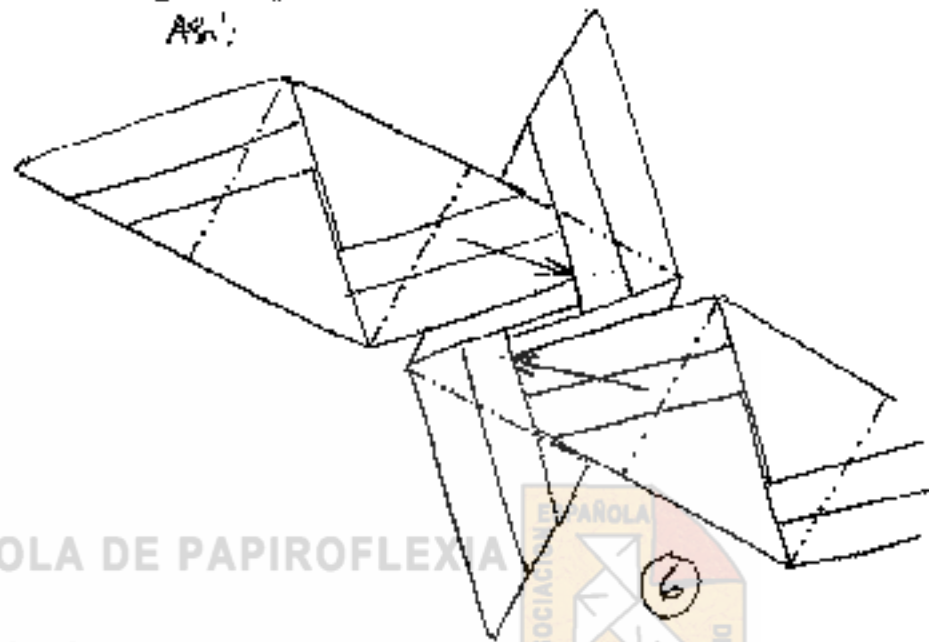

www.pajarita.org

© JORDI ADELL 1996